



ZONING ADMINISTRATOR BULLETIN NO. 9

Bicycle Parking Requirements: Design and Layout

Section 307 of the Planning Code mandates the Zoning Administrator to issue and adopt such rules, regulations and interpretations as are in the Zoning Administrator's opinion, necessary to administer and enforce the provisions of the Planning Code.

Date: August 2013	Relevant Code Sections: Section 155.1 <i>Bicycle Parking Definitions and Standards</i> Section 155.2 <i>Bicycle Parking Applicability and Requirements for Specific Uses</i> Section 155.3 <i>Bicycle Parking Required for City-Owned Properties</i> Section 155.4 <i>Shower Facilities and Lockers</i>
-----------------------------	--

PURPOSE:

Sections 155.1 through 155.3 of the Planning Code regulate bicycle parking requirements. This bulletin specifically regulates design and layout requirements for Class One and Class Two bicycle parking spaces.

RULING:

The San Francisco Planning Department has adopted and shall implement the following standards for bicycle parking.

TYPES OF BICYCLE PARKING

The Planning Code requires two types of bicycle parking defined in Section 155.1(a): 1) Class One spaces are "spaces in secure, weather-protected facilities intended for use as long-term, overnight, and work-day bicycle storage by dwelling unit residents, non-residential occupants, and Employees"; and 2) Class Two spaces are "spaces located in a publicly-accessible, highly visible location intended for transient or short-term use by visitors, guests, and patrons to the building or use."

Bicycle parking spaces are generally in the form of lockers or racks. Bicycle lockers can be used to satisfy the requirements for Class One bicycle parking and bicycle racks can be used to satisfy the requirements for Class Two bicycle parking. When located in a locked area or attended facility, bicycle racks can also satisfy the requirements for Class One bicycle parking.

BICYCLE DIMENSIONS

Standard dimensions for a typical bicycle are 2 feet wide by 6 feet long. All bicycle lockers or racks shall provide a 2 feet by 6 feet space, unless specified in this bulletin for certain types of bicycle racks and lockers. Any type of bicycle parking that does not match the requirements of this bulletin must be approved by the Zoning Administrator (in consultation with the SFMTA) for determination of equivalency.

Class One Bicycle Parking

Class One bicycle parking includes bicycle lockers, bicycle rooms or cages where each bicycle can be individually locked. Bicycle lockers provide secure space with a separate access door for every bicycle. Lockers shall provide a minimum depth of 6 feet and an access door of 2 feet wide when providing space for one bicycle. Some lockers divide the space into two triangular shaped spaces. Such lockers shall provide a slightly larger space as shown in the figure below.

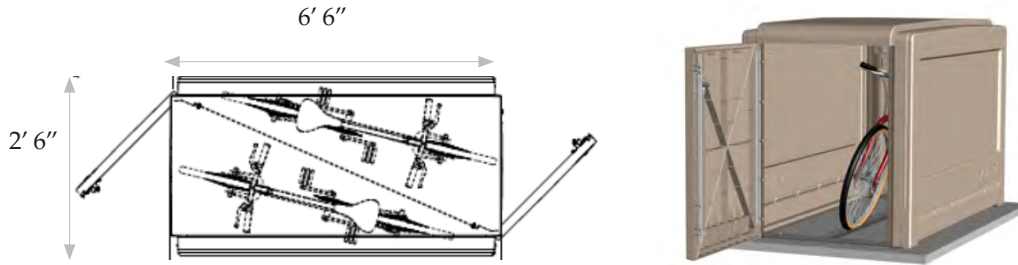

All aisles that provide access to a locker shall be minimum of 6 feet wide.

Where Class One bicycle parking is provided as bicycle racks in a garage, cage or otherwise locked room, any acceptable rack type, including space efficient racks, identified in this bulletin may be used. Required clearances for rows of racks provided in such facilities are described later in this Bulletin.

Class Two Bicycle Parking

Bicycle racks are the most common form of Class Two bicycle parking. Bicycle racks come in many forms and shapes. The most common types are the inverted "U" and the circular racks. The dimensions of such racks are shown here. Each rack that comply with dimensions and requirements set forth in this bulletin will count as two bicycle parking spaces.

All bicycle racks shall:

- support bicycles at two points of contact in order to prevent bicycles from falling;
- allow locking of bicycle frames and one wheel with U-locks;
- use square tubes to resist illegal rack cutting;
- minimize maintenance costs (i.e. galvanized finish resists corrosion);
- not require lifting of a bicycle;
- be mounted securely to the floor; and
- provide visibility to approaching cyclists and pedestrians with a minimum height of 32 inches.

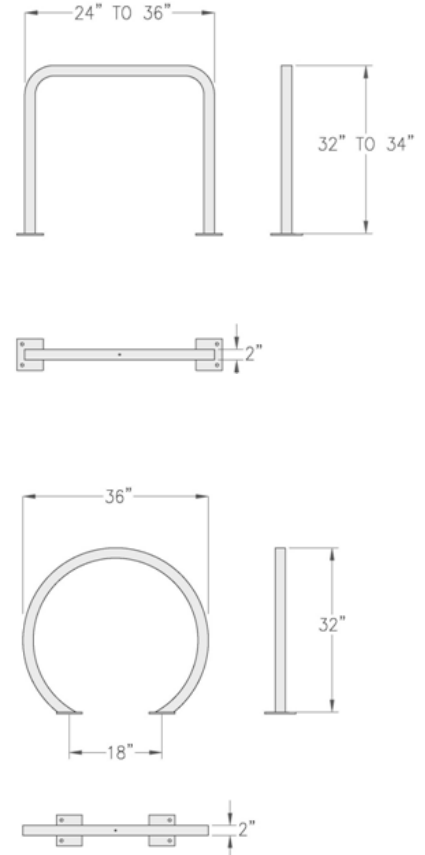

Some acceptable and unacceptable types of bicycle racks are shown below:



Acceptable
These bicycle racks provide two points of support for bicycles. They are constructed with square tubed material which makes the racks resistant to cutting.



Unacceptable
These bicycle racks either provide only one point of support for bicycles, are constructed with round tubed material which makes them prone to cutting, or do not allow locking a frame and wheel directly to the rack with a U-lock.

Alternative bicycle rack types that are not shown here may be considered upon review. For example, some bicycle racks do not provide two points of contact but would secure a bicycle against being knocked over by holding the front wheel stationary, provide an additional point of contact, and allow standard U-locks to lock the frame with a wheel to the rack. Use of such racks must be approved by the Zoning Administrator (in consultation with the SFMTA) for determination of equivalency.

CLEARANCE REQUIREMENTS FOR BICYCLE RACKS

I. Clearance from a vertical obstruction (wall, curb, bollards) for parallel and perpendicular racks

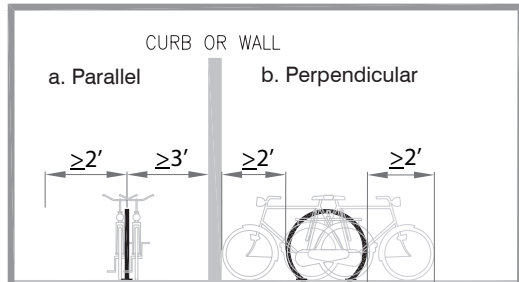

a. When placed parallel to a wall, a rack must be at least three feet away from any vertical obstruction. If the bicycle rack is only two feet away, such rack would only satisfy one required bicycle parking space.

b. When placed perpendicular to a wall, the rack must be at least two feet and preferably three feet away from the vertical obstruction. A standard bicycle sticks out about two feet from a standard inverted U or circular rack.

II. Minimum Vertical Clearance

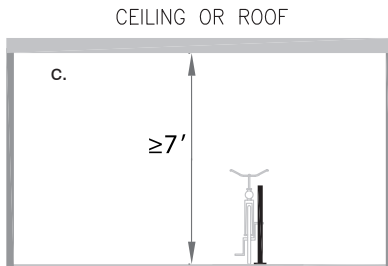

c. Bicycle racks must be located in areas with at least seven feet of clearance between the ground and the ceiling or any elevated obstruction. Bicycle racks also should be installed on surfaces with minimal slopes, preferably as close to 0% grade as possible.

III. Layout of racks perpendicular to the aisles

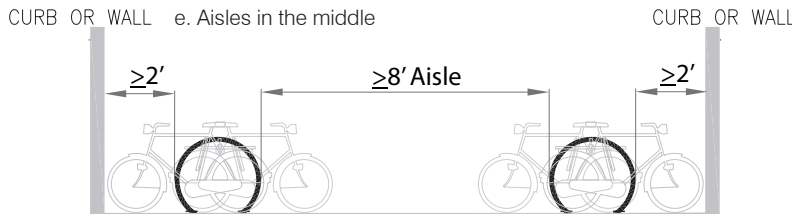
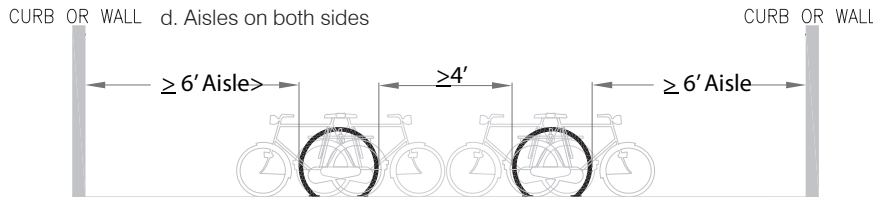

*Illustration (d) through (g)- An **aisle** is the space used to provide access for bicycles in and out of the racks. Aisles may be provided on both sides of the rack as shown in Illustrations (d) and (f) or in the middle of racks as shown in Illustrations (e) and (g).*

*A four feet continuous clear space for **pedestrian circulation** - from the front a bike on one side to the front of the bike on the other side- must be maintained in all aisles. Each bicycle rack shall have at least one such aisle on its side.*

Illustration (d) & (e)- When racks are placed perpendicular to the aisles (III), a standard parked bicycle sticks out of the rack and intrudes into the aisle space about two feet. Therefore, in order to maintain the four feet wide pedestrian circulation, the aisles must be at least 6 feet wide when placed on the sides (d), and at least 8 feet wide when placed in the middle (e). The recommended aisle width for these cases are 8 feet and 10 feet respectively.

IV. Layout of racks parallel to the aisles

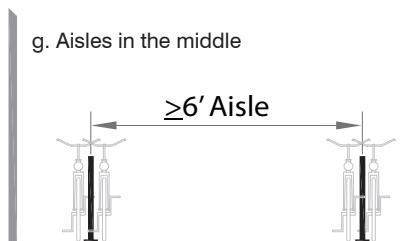
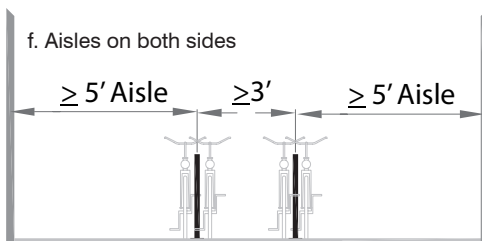
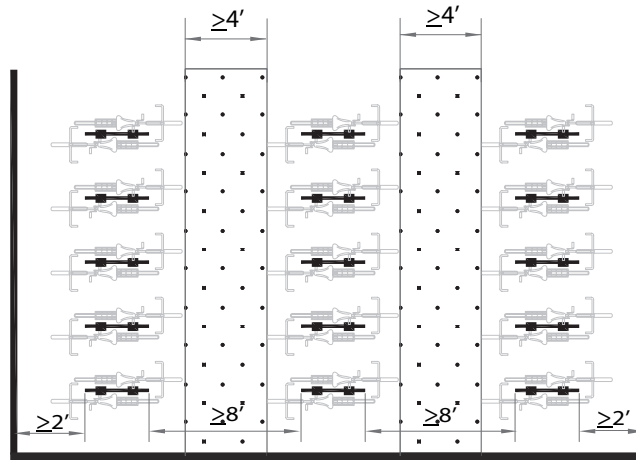

Illustration (f) & (g)-When racks are placed parallel to the aisles, each parked bicycle in the aisle zone consumes about one foot of the aisle width. In order to maintain the four feet wide pedestrian circulation space, the aisles must be at least 5 feet wide when placed on the sides (f), and 6 feet wide when placed in the middle (g). The recommended aisle width for these cases are 7 feet and 8 feet respectively.

In cases shown in illustration (g) racks must be at least three feet from the wall to allow two bikes parked to one rack. If this distance is lower than three feet, such rack would only count for one bicycle parking space.

h. An example of a layout where racks are perpendicular to the aisles and aisles placed between rows of racks

4 Feet Wide Pedestrian Circulation



CONVERTING AUTOMOBILE PARKING TO BICYCLE PARKING

Section 151 of the Planning Code allows replacement of required off-street automobile parking spaces with bicycle parking in order to satisfy the bicycle parking requirements.

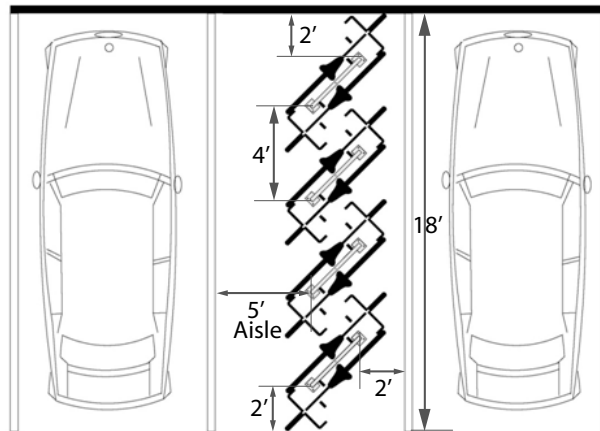

i. Shown here is a potential design to convert one car parking space into eight bicycle parking spaces by installing four inverted U style bicycle racks. This space must be separated from the adjacent car parking spaces with bollards or other physical dividers. If dividers are not provided, the distance between racks and the nearest stripe of car parking space must be at least three feet (increased from two feet shown in the diagram) and the aisle space must be 6 feet (increased from five feet shown in the diagram).

ACCESS ROUTES AND ALLOWED CONSTRICTIONS

Section 151.1(b)(1)(A) of the Planning Code regulates the access routes to and from bicycle parking facilities. Where direct access to the bicycle parking from the street is not provided, this Section requires "a minimum five foot wide hallway or lobby space that leads to the bicycle parking major entrance." It also establishes that "such access route may include up to two limited constriction points such as doorways, provided that these constrictions are no narrower than three feet wide and extend for no more than one foot of distance."

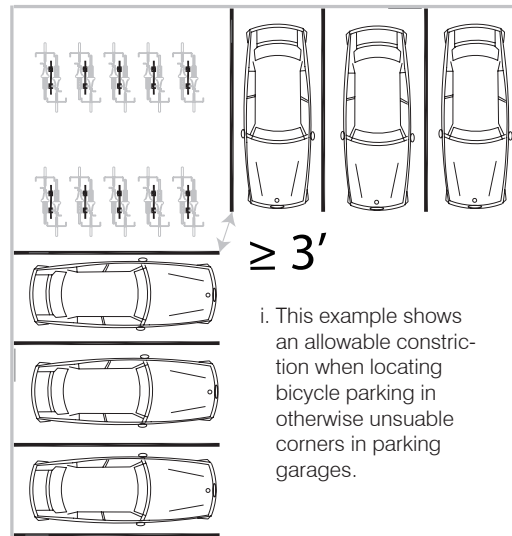

i. This example shows an allowable constriction when locating bicycle parking in otherwise unusable corners in parking garages.

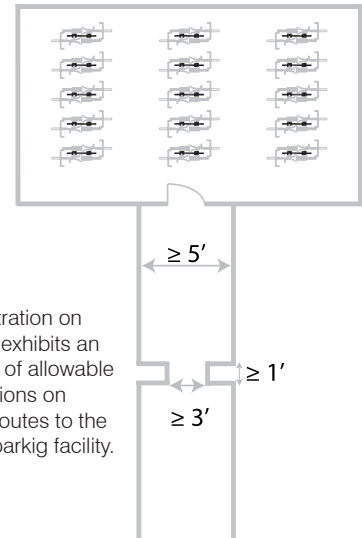

j. The illustration on the right exhibits an example of allowable constrictions on access routes to the bicycle parking facility.

SPACE EFFICIENT BICYCLE PARKING

Some types of bicycle racks, while not meeting the clearance requirements established above, are designed in a way that would meet the basic requirements of an appropriate bicycle rack. Such racks provide a more space efficient layout which can serve smaller buildings; or where layout limitations exist. In no case shall a bicycle parking space require lifting the bicycle's both wheels more than 12" off the ground. Two types of such racks include lift-assist double-decker racks and vertical racks. Below, the minimum spacing measurements of such designs are provided. Any type of bicycle parking that does not match the requirements of this bulletin must be approved by the Zoning Administrator (in consultation with the SFMTA) for determination of equivalency.

Double-Decker Lift-Assist Racks

These bicycle racks allow stacking of bicycles providing a lift-assist pull-out tray. Manual lifting of bicycles off the ground is not necessary to mount the bicycle on the top trays. These racks satisfy the Class One bicycle parking requirements when located in a caged or locked facility. The trays alternate in height off the ground which allows a smaller required clearance between bicycles (17"), measured from mid-point of one rack to mid-point of other rack. The required aisle space is 5 feet and is measured from the nearest edge of bicycles and racks as shown below.

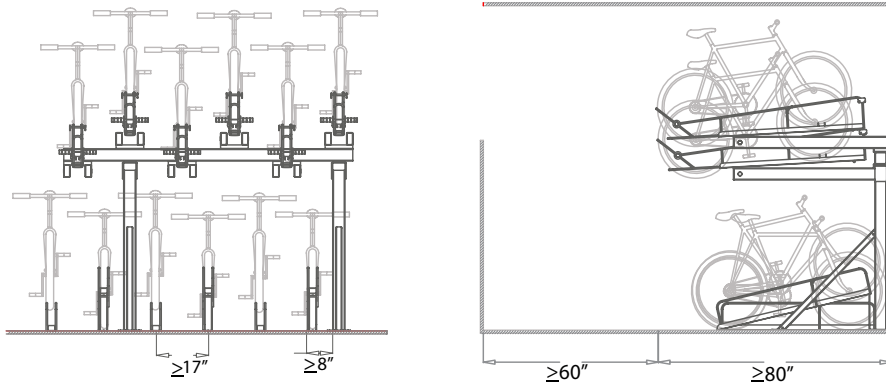

Vertical Bicycle Racks

These bicycle racks allow parking bicycles in a vertical position. This type of rack require manual lifting of bicycles in order to mount to the rack. Vertical bicycle parking may satisfy up to only a third of required bicycle parking per Planning Code Section 155.1(c). A minimum 16" of distance between racks are required to allow for easy mounting which is measured from the mid-point of one rack to the mid-point of another rack. The required aisle space is 5 feet and is measured from the outer edge of bicycles as shown below.

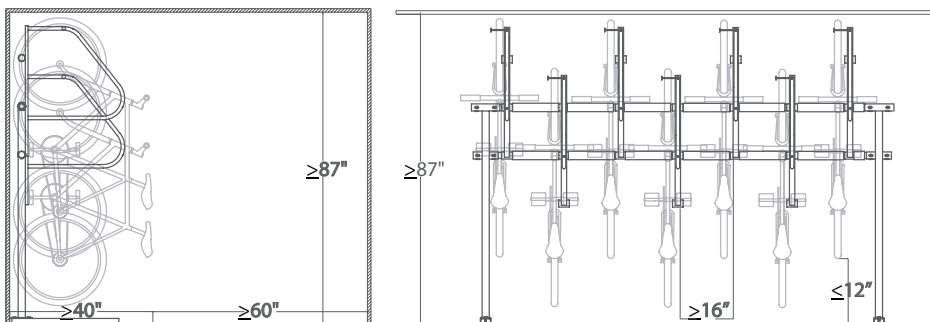

EXISTING BICYCLE PARKING FACILITIES IN CITY-OWNED AND LEASED BUILDINGS AND GARAGES









Section 155.3 of the Planning Code requires City-owned and leased buildings and garages to upgrade their bicycle parking facilities to comply with the requirements of this Ordinance No. 183-13 and this bulletin. The requirements of this bulletin must be followed for all such facilities except for the cases below:

- a. Existing round tubed racks: If such racks comply with all other requirements, the racks need not to be replaced with square tubed racks.
- b. Distance between racks as shown in Illustration (f): A 30" distance between racks is acceptable.

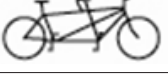
If existing racks are being replaced with new racks, the requirements established in this bulletin apply and the exceptions above will not be permitted.

CHARACTERISTICS OF DIFFERENT TYPES OF BICYCLES

The layout requirements established in this bulletin are based on measurements of a consisting standard bicycle (2 feet by 6 feet). When designing a bicycle parking space, especially Class One spaces, project sponsors are encouraged to consider other types of bicycles, as well as bicycles with trailers or child seats. These types of bicycles are especially important for projects that include 2-3 bedroom units. The Table below provides the dimensions for different types of bicycles. Larger clearances are recommended to accommodate parking of bicycles that are longer and/or wider than a typical bicycle.

BICYCLE TYPE		DIMENSIONS (FEET)		
		Length	Height	Width
Standard Bicycle		6	4	2
Child Bicycle		5	2-3	2
Tandem Bicycle		9	4	2
Cargo Bicycle		8	4	3
Bicycle+Trailer Bike		10	4	2
Bicycle + Child Trailer		10	4	3
Bicycle and Child Seat		6	5	2
Recumbent Bicycle		7	4	3

BICYCLE PARKING SIGNAGE TEMPLATE & USAGE DESIGN GUIDELINES

Section 155.1 of the Planning Code requires signage for Class Two bicycle parking in certain circumstances. When signage is required, the following design layout shall be followed. Such signage shall be located at every entrance that provides access to bicyclists. The plaque shall conform with the Department of Transportation template for bike parking signage (Figure 1). This template was adopted from the California Manual on Uniform Traffic Control Devices Part 9.¹

If the bicycle parking facility is not visible from the point where the plaque is installed, directions or best path to the facility shall be provided. (ex. “At the end of the hallway” or “Use the elevators for one level down”) (Figure 2).

Additionally, a plaque shall be installed at the bike parking facility location that includes the contact information of the manager or entity responsible for maintenance of the facility (Figure 3). Alternatively, this plaque can include only the contact information so long as the font size conforms with the minimums specified in Figure 3.

If necessary, there shall be multiple plaques installed to create a clear path to the bicycle parking facility.

The plaque shall not be smaller than 12” by 18” and shall use non-reflective materials and provide clear contrast between the lettering and the background.

**SIGN TEMPLATE AVAILABLE
FOR DOWNLOAD:**

The template with artwork needed for designing Bicycle Parking signs (available in vector file formats) can be downloaded on the Planning Department’s web site:

<http://bikeparking.sfplanning.org>

¹ http://www.dot.ca.gov/hq/traffops/signtech/mutcdsupp/ca_mutcd2012.htm

Figure 1
MUTCD D4-3 Bicycle Parking Sign Template and Dimen-

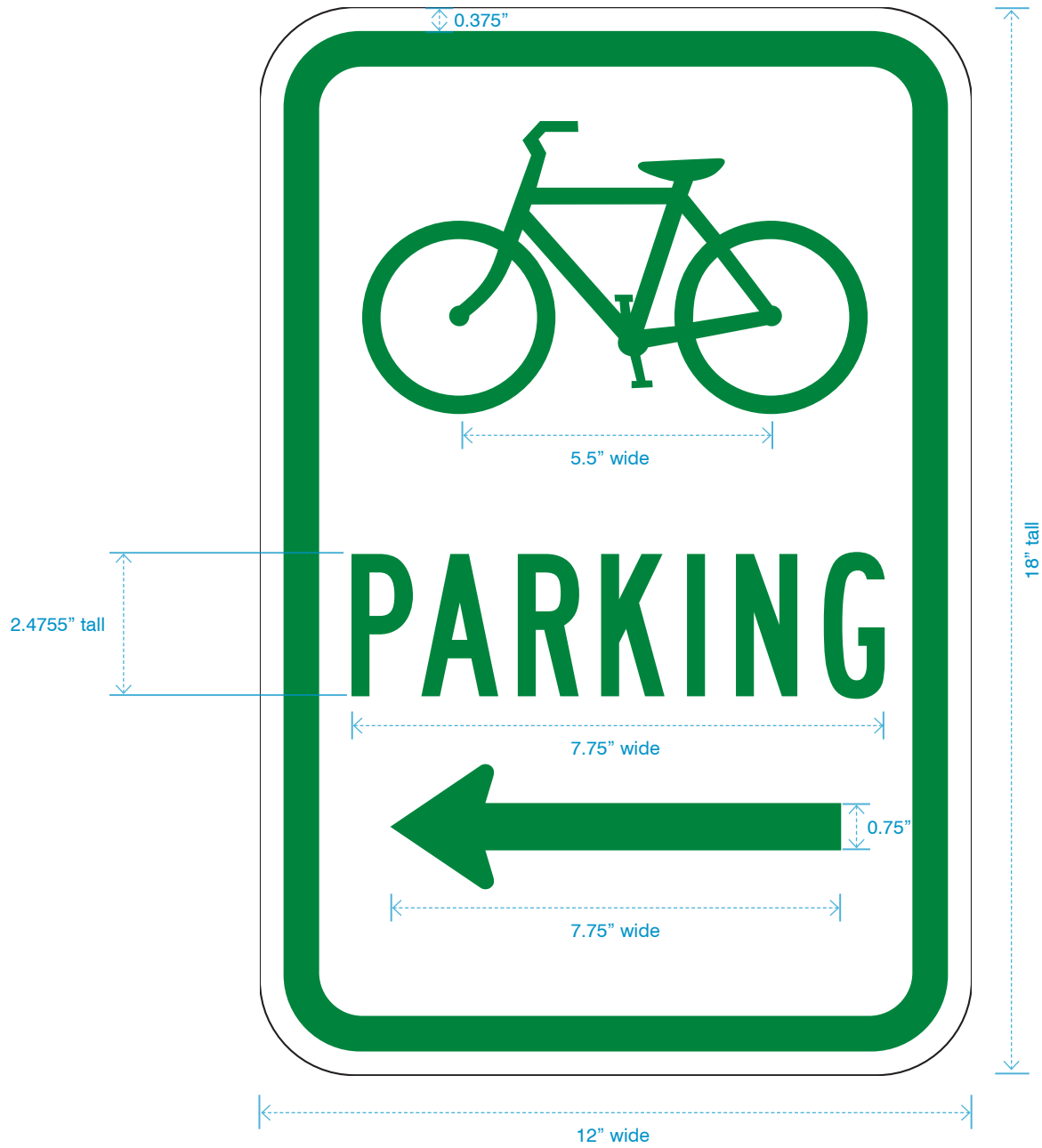

NOTE:

All signs are required to be 12" wide x 18" high, as set forth in the artwork template, and may not be modified.

The D4-3 Bicycle Parking Sign may not be modified.

This template is available on-line at: <http://bikerparking.sfplanning.org>

Figure 2
Bicycle Parking Specific Location Sign Template and Dimensions



NOTE:

All signs are required to be 12" wide x 180" high, as set forth in the artwork template, and may not be modified. The location information font size should 100 point and may not be modified.

This template is available on-line at: <http://xx.sfplanning.org>

Figure 3
Bicycle Parking Facility Maintenance Sign Template and Dimensions



NOTE:

All signs are required to be 12" wide x 18" high, as set forth in the artwork template, and may not be modified. The facility maintenance contact information font size should 80 point and may not be modified.

This template is available on-line at: <http://xx.sfplanning.org>



**FOR MORE INFORMATION:
Contact the San Francisco Planning Department**

Central Reception
49 South Van Ness Avenue, Suite 1400
San Francisco, CA 94103

TEL: **628.652.7600**
WEB: **www.sfplanning.org**

Planning counter at the Permit Center
49 South Van Ness Avenue, 2nd Floor
San Francisco, CA 94103

EMAIL: **pic@sfgov.org**
TEL: **628.652.7300**